

HASZNÁLATI ÚTMUTATÓ

PANTHER[™] FLOW 3

Szűrt levegő befúvó rendszerrel ellátott,
automata hegesztő fejpajzs

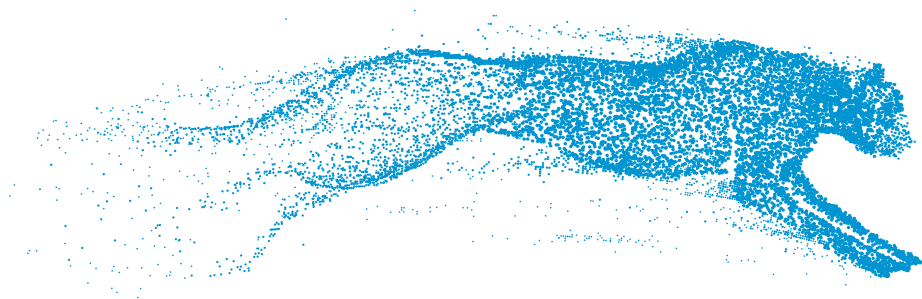

Figyelem!

Kérjük a fejpajzs használata előtt olvassa át és értelmezze a használati utasítás tartalmát!
Különösen vegye figyelembe a veszélyre figyelmeztető bekezdéseket és ismerje meg a hibás működésre utaló információkat!

1. BEVEZETŐ

A PANTHER FLOW szűrt levegő befúvó rendszerrel ellátott automata hegesztő fejpajzs egy kombinált, arc és légzésvédelmet biztosító eszköz. Kérjük, figyelmesen olvassa el ezeket az utasításokat a kicsomagolás előtt. A megfelelő használathoz szükséges információkat használati útmutató tartalmazza, amennyiben kérdés e van a használattal kapcsolatban, kérjen segítséget forgalmazójától.

A LÉGZÉSVÉDELMI RENDSZERT NEM SZABAD HASZNÁLNI AZ ALÁBBI ESETEKBE:

- A felhasználó egészségére és biztonságára veszélyes környezetben, olyan környezetben, ahol az oxigénszint 17% alatt van vagy a levegő ismeretlen anyagokat tartalmazhat.
- Zárt vagy nem szellőztetett környezetben, például alagsorban stb.
- Láng vagy hőszugárzás közelében.
- Robbanásveszélyes zónában.
- Nagyonyomású zónában.
- Ha a légzésvédelmi rendszer leáll a felhasználónak azonnal el kell hagynia a szennyezett területet.
- Ha a szűrő nincs telepítve.

NE engedje, hogy víz vagy más folyadék kerüljön a járókerék kamrába, a szűrőbe vagy az elemtartóba.

2. JÓVÁHAGYÁSOK

A rendszer megfelel az európai szabvány követelményeinek:

EN12941: 1998 + A2: 2008 osztály TH3 P R S L

A légzőrendszer úgy van kialakítva, hogy a szűrt levegőt egy légzőcsövön keresztül biztosítsa a hegesztő számára. A berendezés olyan környezetben használható, amelyhez egy TH3P osztályú légzőkészülék szükséges. Védelmet nyújt az artikuláris szennyeződéssel szemben.

A légzőrendszerben minden összetevőnek a gyártó által jóváhagyott alkatrésznek kell lennie és a jelen útmutató utasításainak megfelelően kell használni.

Bejelentett szervezet: INSPEC International Limited 56 Leslie Hough Way, Salford, Greater Manchester, M6 6AJ Egyesült Királyság (bejelentett szervezet száma: 0194)

- 1. A jótállás nem érvényes, ha a terméket helytelenül vagy nem jóváhagyott összetevőkkel, alkatrészekkel használja.**
- 2. Csak a jóváhagyott részecskeszűrő és az előszűrő használható ezzel a rendszerrel. Más gyártók szűrőit semmilyen körülmények között sem szabad használni.**

3. FIGYELEM ÉS A FELHASZNÁLÁSRA VONATKOZÓ KORLÁTOZÁSOK

Minden használat előtt ellenőrizze a légzőrendszer károsodását és ellenőrizze, hogy megfelelően működik-e. A légzőrendszer használata előtt a levegőáramlást ellenőrizni kell, hogy a megfelelő légmennyiség biztosítva legyen.

Mindig viseljük a légzőrendszert szennyezett területen belül. Ne vegyük le a pajzsot a fejünkről és ne kapcsoljuk ki a levegőszűrő egységet a szennyezett területen belül, mert fennáll a magas CO₂-koncentráció és az alacsony oxigénszint veszélye.

Ha nem biztos abban, hogy a szennyezés koncentrációja vagy a berendezés teljesítménye alkalmas a biztonságos munkavégzésre, kérdezze meg az munkavédelmi felelőst.

4. TECHNIKAI ADATOK

Méret (befúvó-szűrő egység)	240 x 165 x 70 mm
A hegesztőpajzs	PANTHER FLEX RC
Levegő szűrő	1 x TH3 P R SL
Légáram	Minimális légáram: 165 l/perc Névleges légáram : 1 fokozat: 170 l/perc 2 fokozat 200 l/perc 3 fokozat: 230 l/perc
Zajszint	Max: 70 dB
Működési hőmérséklet	-5°C~55°C
Tárolási hőmérséklet	-10°C~55°C
Akkumulátor típusa	Újratölthető Li-ion 11.1V /6800mA
Várható akku üzemidő	1 fokozat >8h 2 fokozat>6h 3 fokozat>4h
Akkumulátor töltési ideje	3.5 óra
Akkumulátor várható élettartama	500 töltés Az élettartam függ a légáramtól és a szűrőterheléstől.
LCD	Levegőáram és adatok Akkumulátor-kapacitás Az akkumulátor hőmérséklete Szűrő állapot

5. KICSOMAGOLÁS/ÖSSZESZERELÉS

Ellenőrizze, hogy a csomag tartalmazza-e a megfelelő számú alkatrészt, az 1. ábra szerint.

Ellenőrizze, hogy a készülék teljes, sértetlen és az összeszerelés megfelelő.

A sérült vagy hibás alkatrészeket használat előtt cserélni kell.







A csomag tartalma:

1. Szűrt levegő bevezető rendszer + hegesztőpajzs
2. A légzőrendszer (turbóegység + szűrő + deréköv)
3. Lítium-ion akkumulátor
4. A levegőcső, tűzálló burkolata és mindkét végcsatlakozó
5. A vállheveder
6. A légáramlásmérő
7. A lítium-ion akkumulátortöltő
8. A hordtáska

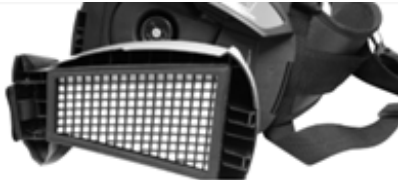

Ha a fenti alkatrészek bármelyike nem szerepel a készletben, kérjük, azonnal forduljon a forgalmazóhoz.

5.1 Szűrőcsere

1		2	
Távolítsa el a szűrő fedelét a szűrőfedél reteszelésének oldásával.		A szűrőbetétek hozzáférhetővé válnak..	
3		4	
Távolítsa el a használt szűrőt úgy, hogy kiemeli a szűrő fedélből.			
5		6	
Távolítsa el az előszűrőt.		Tisztítsa meg a szikrafogót, ha szükséges.	

Az előszűrő és a szűrő várható élettartama 12 hónap. Intenzív használat esetén rendszeresen ellenőrizze a szűrő tisztaságát, és szükség esetén 12 hónapnál gyakrabban cserélje ki.

5.2 Akkumulátor elhelyezése és cseréje.

1		2	
Csúsztassa az akkumulátort a szűrőegység hátulja felé.		Győződjön meg róla, hogy az akkumulátor le van reteszelve.	
3		4	
Az akkumulátor feltölthető a szűrőegységben vagy külön is.			

Az akkumulátor részben fel van töltve szállításkor.

Az első használat előtt 100% (4 sáv a kijelzőn) ra kell feltölteni.



Javasoljuk az akkumulátorok 100% -os feltöltését minden használat előtt!

A töltőt nem szabad más célokra használni, mint amire a készüléket tervezték.



Ne töltsé az akkumulátort robbanásveszélyes területen! A töltőt csak beltérben szabad használni!

A töltő automatikusan szabályozza a töltést, ha az akkumulátor teljesen fel van töltve, 100% -on tartja (lebegő töltés).

A töltési idő 3-4 óra.

Az akkumulátor hosszú tárolási idő alatt lemerül. Mindig töltsé fel az akkumulátort, ha az eszközt több mint 15 napig tárolta. Ha az akkumulátor új vagy 3 hónapnál hosszabb ideig tárolásra került, akkor töltsé fel és legalább kétszer egymás után merítse le, hogy elérje a névleges töltési kapacitást.



Akkumulátortöltő :



1. Csatlakoztassa az akkumulátort a töltőhöz. A csatlakozó az akkumulátor felett van.
2. Csatlakoztassa a töltőt a hálózati csatlakozóhoz.
3. A töltés állapotát a hálózati töltő piros LED-je jelzi.
4. A töltés befejezése után a lebegő töltés aktívává válik: a piros LED kikapcsol és zöld LED világít.
5. Húzza ki a töltőt a hálózati aljzatból (ne tartsa a töltőt a hálózati csatlakozóban ha nincs használatban).

5.3 A légzőrendszer felszerelése az övre.

1		2	
Távolítsa el a szíj felszabadító csatját.		Távolítsa el a rögzítőszíjat a derék-csatlakozó két övhurokjából.	
3		4	
Húzza át a rögzítőszíjat a légzőrendszer két övnyílásán keresztül.		Helyezze a tépőzárat a két nyílás közé.	
5		6	
Fordítsa meg a szűrőrendszert, és rögzítse a tépőzárat a szíjra		Tegye vissza a rögzítőszalagot a két övhurokra.	
7		8	
Tegye vissza a csatot.		Csatlakoztassa a hevedert az öv 4 műanyag rögzítőjéhez.	

Ügyeljen arra, hogy az öv biztonságosan rögzítve legyen!



5.4 Levegőcső csatlakoztatása

1		2	
Csatlakoztassa a levegőcsövet a légzőrendszerbe, és csavarja az óramutató járásával megegyező irányba, hogy rögzítse a helyzetét.		Csatlakoztassa a cső másik végét a fejfedőhöz hasonló módon.	

Ellenőrizze, hogy a levegőcső szorosan rögzítve van-e. Ha a cső meghibásodott, cserélje ki! Az összes alkatrészt a jelen kézikönyv szerint kell felszerelni / használni, hogy a berendezés a megadott védelmet kínálja. Ha bármelyik alkatrész hiányzik vagy ha valami nem érthető, akkor lépjen kapcsolatba a forgalmazóval.

6. HASZNÁLAT ELŐTT

6.1 Légáram teszt



1		2	
Csatlakoztassa a légcsövet a turbóegységhez, és csavarja az óramutató járásával megegyező irányba, hogy lezárja.		Helyezze az áramlásmérőt a cső végére.	
3		4	
Nyomja meg az ON gombot és tartsa a csövet függőleges helyzetben szemmagasságban.		A légáram akkor elegendő, ha a golyó eléri az O minimális áramlási szintet.	

1. A légáramot meg kell mérni használat előtt!

2. Ha a golyó nem éri el a minimális áramlási szintet, ne használja a rendszert!



Cserélje ki a szűrőt vagy az akkumulátort, és ismétlje meg a mérést!

6.2 Légáram ellenőrzése

1		2	
Távolítsa el a csövet a sisakról és nyomja meg az ON gombot		Fedje le a levegőt a kezével és várjon kb. 15 másodpercet.	

Ha a riasztás nem működik, kérjük, javítsa vagy cserélje a rendszert..

6.3 Rögzítés

1		2	
Húzza le az arctömítő gyűrűjét és tegye fel a fejére.		Állítsa be a fejfedőt megfelelő feszességre (nyomja meg és fordítsa balra a lazításhoz, jobbra a meghúzáshoz)	

Győződjön meg róla, hogy az arc tömítése helyesen van elhelyezve, ellenkező esetben nem kap elegendő tömítést a megfelelő védelmi tényező biztosításához.

7. LCD ÉS KEZELÉS

7.1 LCD funkciók

A PANTHER FLOW egységen található LCD kijelző mutatja a működési paramétereket.



Az 1. ábra mutatja az aktuális légáramlás adatait.

A 2. ábra mutatja a légáram szintjét.









A 3. ábra a szűrő állapotát mutatja.

A 4. ábra mutatja az akkumulátor töltöttségét.

Az 5. ábra mutatja az akkumulátor hőmérsékletét.

Bármelyik közülük villogni fog, ha a PANTHER FLOW egység hibás.

7.2 Működés

 1x ON	Kapcsolja be a készüléket az ON gomb egyszeri megnyomásával.	
 2x ON	Nyomja meg újra az ON gombot, a levegőáramlás az 1. szinten (~ 170L / perc).	
 3x ON	Nyomja meg újra az ON gombot, a levegőáramlás a 2. szinten (~ 200L / perc).	
 4x ON	Nyomja meg újra az ON gombot, a levegőáramlás a 3. szinten (~ 230L / perc). Nyomja meg újra az ON gombot, a levegőáramlás visszatér az 1. szintre (~ 170L / perc).	

1. A légzőrendszer kikapcsolja a befűvő egységet, ha több mint 3 másodpercig nyomva tartja az OFF gombot.
2. A légzőrendszer leállítja az egész áramkört és alvó üzemmódra vált, ha a befűvő egység több mint 30 percig ki van kapcsolva. Az ON gomb megnyomásával aktiválhatja a rendszert.
3. A készüléket -5°C és $+5^{\circ}\text{C}$ közötti hőmérséklet-tartományban és 90% -nál kisebb relatív páratartalom mellett kell működtetni.

8. KARBANTARTÁS ÉS TÁROLÁS

Ellenőrizze a berendezést naponta, és mindig ellenőrizze amikor hibajelzést tapasztal!

8.1 Karbantartás

- A légzőrendszert rendszeresen ellenőrizni kell, és ki kell cserélni ha sérült és szivárgást okoz.
- A szűrőt ki kell cserélni, ha meghibásodott vagy eltömődött és nem biztosít elég légáramot.
- A levegőcsövet ki kell cserélni, ha megtörik vagy megrongálódott.
- Az akkumulátort fel kell tölteni, ha lemerült.
- Puha ruhával törölje le a külső felületeket. Ne használjon vizet!
- A szűrőt az előszűrővel együtt kell cserélni.

8.2 Tárolás

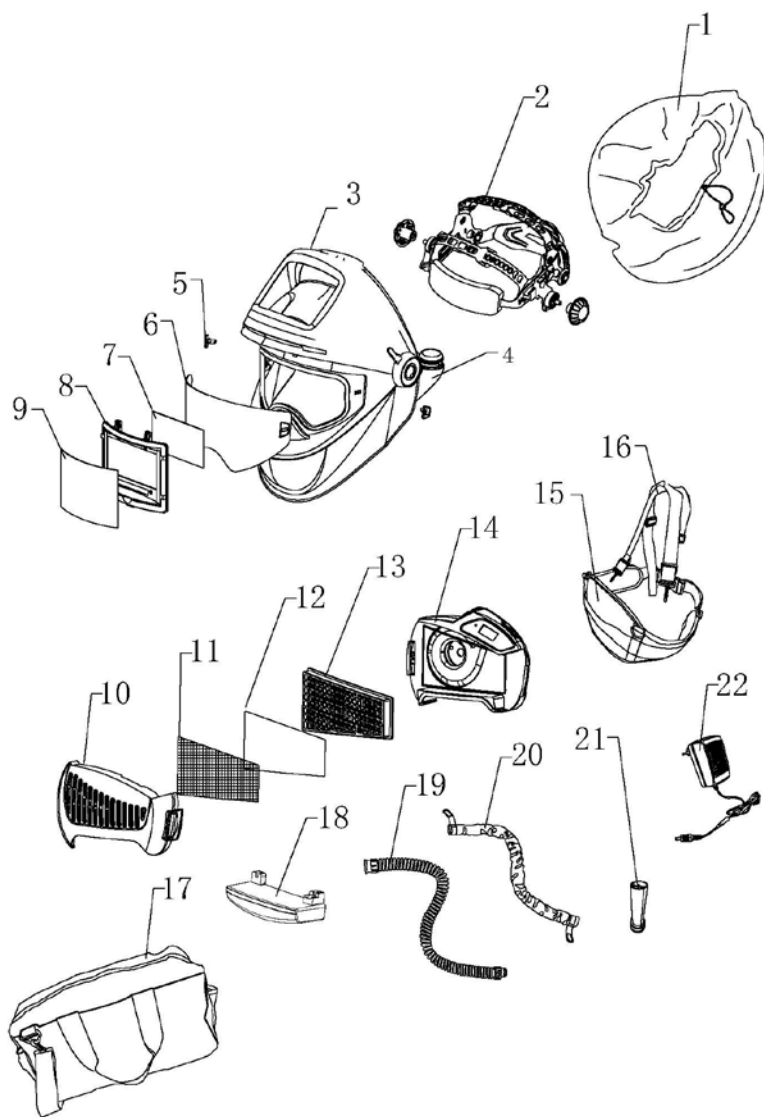

- A légzőrendszert száraz, tiszta környezetben kell tárolni, -10°C és $+55^{\circ}\text{C}$ közötti hőmérsékleten és max. 90% relatív páratartalom mellett.
- Ha a készüléket 0°C alatti hőmérsékleten tárolják, az akkumulátort fel kell melegíteni, hogy teljes akkumulátorkapacitást érjen el. A berendezést védeni kell a portól és más szennyeződésektől.
- Ha a készüléket hosszabb ideig nem használja, az akkumulátort teljesen fel kell tölteni, eltávolítani a befűvő egységből és külön kell tárolni.

9. ALKATRÉS Z LISTA



Jelölés	Cikkszám	Megnevezés
1	8PNTHRFLW3FCSL	Arcvédő szövet kámzsa
2		Fejkosár
3	8PNTHRFLXRC	PANTHER FLEX RC Felyitható Automata heg. fejpajzs
4	-	-
5	-	-
6	8PNTHRFLXGRL	Köszörűs, panoráma védőplexi
7	8PNTHRFLXINNCL	Belső védőplexi
8	-	Automatikusan elsötétető szűrő (ADF)
9	8PNTHR51OUTCL	Külső védőplexi
10	8PNTHRFLWFC	Szűrőfedél
11	8PNTHRFLWSPRKA	Szikrafogó
12	8PNTHRFLWPRF	Előszűrő x5
13	8PNTHRFLW3FLT	Szűrőbetét (TH3)
14	-	Befúvó egység
15-16	8PNTHRFLWWBDS	Derékszj, vállheveder
17	-	Hordtáska
18	8PNTHRFLW3RCB	Újratölthető Li-ion akku (6800mA)
19-20	8PNTHRFLW3BRTA	Légszállító cső+burkolat
21	8PNTHRFLWPATU	Légáram mérő
22	8PNTHRFLWBTTCH	Akkutöltő

10. HIBAE LHÁRÍTÁS

Hiba jelzés	A hiba oka	Megoldás
Hibakód «E01» + “Warning” villog	<ol style="list-style-type: none"> 1. A motor beragadt 2. A motor tönkrement 3. Külső erő által okozott légfűvő szerkezeti meghibásodás 4. Áramköri meghibásodás 	Ellenőrizze és távolítsa el a fizikai hibát, és indítsa újra a rendszert. Ha az LCD még mindig E01-et mutat, akkor forduljon a forgalmazóhoz.
Hibakód «E02» + “Warning” villog	<ol style="list-style-type: none"> 1. A motor sérült 2. A motor lapátkereke dörzsöli a házat. 3. Az áramkör túl nagy áramot kap. 	Ellenőrizze és távolítsa el a fizikai hibát, és indítsa újra a rendszert. Ha az LCD még mindig E02-et mutat, akkor forduljon a forgalmazóhoz.
 + “Warning” villog + figyelmeztető hang	Alacsony akku. töltöttség	Töltse fel az akkumulátort
 + “Warning” villog + figyelmeztető hang	Szűrő telítődött Cső eldugult.	Távolítsa el a dugulást okozó akadályt, cserélje ki a szűrőt Tisztítsa meg a csövet
 villog + figyelmeztető hang	Az akkumulátor magas hőmérséklete	Álljon meg a munkával, tartson szünetet.
Nincs légáram, nincs hibajelzés.	<ol style="list-style-type: none"> 1. Nincs áram 2. Az akkumulátor érintkezésen feltöltve 	Töltse fel az akkumulátort Ellenőrizze az akkumulátor érintkezését
Az akkuidő túl rövid.	<ol style="list-style-type: none"> 1. Az akkumulátor nincs teljesen feltöltve 2. A szűrő telítődött 3. Az akkumulátor sérült 	Töltse fel az akkumulátort Távolítsa el az elzáródást, cserélje a szűrőt Az akku cseréje
A levegőellátás közben szokatlan szagokat érez.	<ol style="list-style-type: none"> 1. Szűrő sérült 2. A cső meghibásodott, sérült 3. ADF pajzs héja sérült 	Hagyja el azonnal az aktuális területet. <ol style="list-style-type: none"> 1. Cserélje ki a szűrőt 2. Cserélje ki a csövet 3. Cserélje az ADF pajzsot
Nem elégséges a levegő ellátás.	<ol style="list-style-type: none"> 1. Légzéscső megszakadt 2. A szűrő eltömődött 	<ol style="list-style-type: none"> 1. Ellenőrizze a csőcsatlakoztatást a pajzsra és a légző rendszerre 2. Cserélje ki a légzőcsövet 3. Távolítsa el az akadályokat, cserélje ki a szűrőt

11. JELÖLÉSEK

Táplált szűrőberendezés:

- EN 12941: 1998 Légzésvédők. Rásegíteses, szűrési típusú légzésvédő készülék sisakkal vagy kámszával. Követelmények, vizsgálat, megjelölés
- A készülék TH3 P R (SL) osztályozású.
"TH3": védelmi szint
"P R": a szűrők típusa ("P" = részecskeszűrő, "R" = újrahasznosítható részecskeszűrők)
"SL" : a szűrőt folyadék- és szilárdanyag-részecskék ellen tesztelték.

Figyelmeztető hangjelzés

Minden rács 100 ms időtartamot jelent. A szürke a hangjelzés, az üres rács csendes időszak. Ha több folyamatos rács szürke, akkor folyamatos hangjelzés hallható.

Például, ha az áram túlterhelt, a rendszer ezt a hangot adja:

***BEP BEP BEEEEEP.**

100 ms per rács											
	0	1	2	3	4	5	6	7	8	9	10
Telepítse az akkumulátort	■										
Kapcsolja be a rendszert	■										
Módosítsa a légáramlási sebességet	■										
Kapcsolja ki a rendszert	■	■	■	■	■						
Áram túlterhelés*	■		■		■	■	■	■	■		
Levegőcső elzáródás	■		■	■	■	■	■				
Túlmelegedés	■		■	■	■	■	■	■	■	■	■
Alacsony akkumulátor tölt.	■		■								
Szűrő telítődés	■		■		■						

MANUAL DE UTILIZARE

PANTHER™ FLOW 3

Sistem de protecție respiratorie cu presiune pozitivă a aerului și aducție de aer

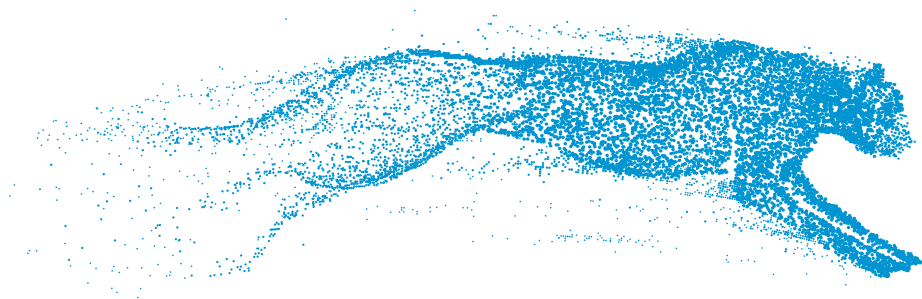

Avertisment!

Citiți și înțelegeți toate instrucțiunile din acest manual înainte de a folosi masca! Pericol de accidentare gravă în cazul în care utilizatorul nu respectă avertizarea de mai sus și / sau nu respectă instrucțiunile de utilizare.

INTRODUCERE

Masca cu sistem de protecție respiratorie este un dispozitiv combinat de protecție facială/respiratorie care asigură un grad ridicat de protecție și confort în timpul sudării. Citiți cu atenție aceste instrucțiuni înainte de a despacheta sistemul. Pentru o utilizare corespunzătoare a echipamentului, familiarizați-vă cu acest manual de utilizare sau contactați producătorul pentru asistență.

SE INTERZICE UTILIZAREA MASTII CU SISTEM DE PROTECȚIE RESPIRATORIE:

- În medii periculoase pentru sănătatea și siguranța utilizatorului, în medii cu un nivel al oxigenului sub 17% sau care conține substanțe necunoscute.
- În spații mici sau neaerisite, de exemplu subsoluri, etc.
- Lângă surse de foc deschis sau radiații termice.
- În zone cu risc de explozie.
- În zone expuse vânturilor puternice.
- În cazul în care sistemul de protecție respiratorie nu mai funcționează: utilizatorul va părăsi imediat zona contaminată.
- În cazul în care filtrul nu este instalat.

NU permiteți pătrunderea apei sau altor lichide în camera ventilatorului motorizat, în filtru sau în compartimentul

acumulatorului.

2. OMOLOGĂRI

Sistemul întrunește cerințele standardului european:

EN12941:1998+A2:2008 clasa TH3 P R S L

Sistemul de protecție respiratorie este conceput pentru alimentarea de aer filtrat către casca de sudură a utilizatorului prin intermediul unui tub de respirație. Echipamentul poate fi utilizat în medii care necesită purtarea unui dispozitiv de protecție respiratorie din clasa TH3P. Acesta asigură protecție în spațiile cu particule contaminante.

Toate componentele sistemului de protecție respiratorie vor fi omologate cu piesele producătorului și vor fi utilizate în conformitate cu instrucțiunile din acest manual.

Organismul notificat: INSPEC International Limited 56 Leslie Hough Way, Salford, Greater Manchester, M6 6AJ Marea Britanie (organismul notificat nr. 0194)

- 1. Omologarea nu este valabilă dacă echipamentul este utilizat incorect cu piese sau componente neaprobate.**
- 2. Cu acest sistem se pot folosi doar filtre de particule și prefiltre. Nu se vor utiliza în niciun caz filtre provenite de la alți producători.**

3. AVERTISMENT ȘI LIMITĂRI ÎN UTILIZARE

Înainte de orice utilizare, controlați sistemul de protecție respiratorie pentru a vedea dacă nu este deteriorat și dacă funcționează corespunzător. Înainte de a utiliza sistemul, testați aducția de aer pentru a vedea dacă la cască ajunge un volum de aer suficient.

Purtați sistemul de protecție întotdeauna și nu scoateți protecția capului sau nu închideți filtrul de aer decât atunci când ieșiți din zona contaminată, altfel există riscul acumulării de dioxid de carbon și de scădere a concentrației de oxigen la nivelul capului, protecția respiratorie fiind astfel compromisă aproape total sau total.

Dacă nu sunteți siguri de concentrația contaminării din aer sau despre capacitatea echipamentului, adresați-vă responsabilului cu siguranța industrială.

4. SPECIFICATION

Dimensiune (grupul de ventilație motorizată)	240 x 165 x 70 mm
Masca sudura	PANTHER FLEX RC
Filtru de aer	1 x TH3 P R SL
Flux de aer	Debit minim garantat de producător: 165 l/min Debit de aer nominal: Nivel 1: 170 l/min Nivel 2: 200 l/min Nivel 3: 230 l/min
Nivel de zgomot	Max: 70 dB
Temperatura de funcționare	între -5oC și +55oC
Temperatura de depozitare	între -10oC și +55oC
Tip acumulator	Acumulator cu Li-ion reîncărcabil, 11.1V /6800mA
Timpu estimat de funcționare a acumulatorului	Nivelul 1 >8h Nivelul 2 >6h Nivelul 3 >4h
Timpu de încărcare a acumulatorului:	3,5 ore
Durata de viață a acumulatorului	500 încărcări Timpu de funcționare în funcție de debitul de aer și sarcina filtrului
Ecran de afișare LCD	Nivelul și date privind fluxul de aer Capacitatea acumulatorului Temperatura acumulatorului Starea filtrului

5. DESPACHETAREA / MONTAREA SISTEMULUI

Verificați dacă a fost livrat numărul corect de componente, conform Fig. 1. Verificați dacă sistemul este complet, nedeteriorat și corect asamblat. Componentele deteriorate sau defecte vor fi înlocuite înainte de utilizarea sistemului.







Pachetul trebuie să includă următoarele:

1. Masca de sudură cu aducție de aer + protecția pentru umeri
2. Sistemul de protecție respiratorie (unitatea turbo + filtru + cureaua de susținere)
3. Acumulator cu Li-ion
4. Tubul de respirație, cu protecție antifoc și fittinguri la ambele capete
5. Harnașamentul pentru umeri
6. Dispozitivul de testare a fluxului de aer
7. Kitul de încărcare acumulator cu Li-ion
8. Geanta de transport

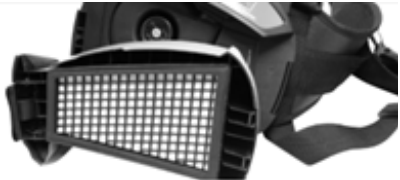

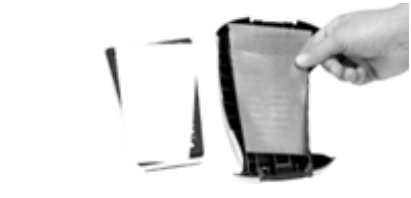

În cazul în care nu vi s-a livrat una dintre componentele de mai sus, contactați imediat furnizorul.

5.1 Înlocuirea filtrului

1		2	
Scoateți capacul filtrului apăsând pe mecanismul cu resort al acestuia.		Capacul se deschide.	
3		4	
Ridicați filtrul uzat din capacul filtrului.			
5		6	
Scoateți prefiltrul.		Curățați dispozitivul parascănteii, dacă este cazul.	

Durata de funcționare estimată a prefiltrului și filtrului este de 12 luni. În condiții de utilizare intensă, verificați periodic gradul de curățare a filtrului și schimbați filtrul , dacă este nevoie, mai devreme de 12 luni.

5.2 Installing and charging the battery

1		2	
Glisați acumulatorul spre partea din spate a unității de filtrare.		Verificați dacă acumulatorul este bine fixat în poziție.	
3		4	
Acumulatorul poate fi încărcat direct în unitatea de filtrare sau separat.			

La livrare, acumulatorul este încărcat parțial. Acesta trebuie reîncărcat în procent de 100% (4 bar) înainte de prima utilizare.



Se recomandă încărcarea bateriilor la 100% înainte de fiecare utilizare!

Încărcătorul va fi folosit doar în scopurile pentru care a fost conceput. Nu încărcați acumulatorul în medii potențial explozive! Încărcătorul va fi folosit întotdeauna în spații interioare!



Încărcătorul reglează automat operațiunea de încărcare atunci când acumulatorul s-a încărcat complet, menținându-l constant la 100% (încărcare intermitentă).

Timpul de încărcare este de 3-4 ore.

Bateria se va descărca după perioade mari de inactivitate. Dacă sistemul a fost depozitat mai mult de 15 zile, este întotdeauna necesară încărcarea acumulatorului. Dacă acumulatorul este nou sau a fost depozitat mai mult de 3 luni, încărcați-l și lăsați-l să se descarce de cel puțin două ori consecutiv pentru a atinge capacitatea de încărcare nominală / de referință.



Încărcarea acumulatorului:



1. Cuplați acumulatorul la încărcător. Conectorul este situat deasupra acumulatorului.
2. Cuplați încărcătorul la priza de alimentare..
3. Starea acumulatorului este afișată de indicatorul cu LED roșu de pe încărcător.
4. După ce acumulatorul este încărcat complet se activează încărcarea intermitentă: indicatorul LED roșu se stinge și se aprinde indicatorul LED verde.
5. Decuplați încărcătorul de la sursa de alimentare (nu mențineți încărcătorul cuplat la sursa de alimentare dacă nu-l folosiți).

5.3 Instalarea sistemului de protecție respiratorie pe curea

1		2	
	Eliberați catarama de prindere a curelei.		Scoateți cureaua din cele două găici de la conectorul de braț.
3		4	
	Treceți cureaua de fixare prin cele 2 găici ale sistemului de protecție respiratorie.		Poziționați banda Velcro® între cele două găici.
5		6	
	Ațașați sistemul de filtrare și fixați banda Velcro pe curea.		Treceți cureaua de fixare înapoi prin cele două găici.
7		8	
	Fixați la loc catarama.		Ațașați harnașamentul la cele 4 componente de plastic ale curelei

Verificați dacă este bine fixată cureaua!





5.4 Conectarea tubului

1		2	
Conectați tubul de aer la sistemul de protecție respiratorie și răsuciți-l în sensul orar pentru a-l fixa pe poziție.		Cuplați celălalt capăt al tubului la casca de protecție în același mod.	

Verificați dacă tubul de respirație este bine fixat. Dacă tubul este spart, înlocuiți-!!! Toate componentele vor fi instalate / utilizate în conformitate cu acest manual dacă echipamentul trebuie să asigure protecția specificată. Dacă lipsește vreo componentă sau ceva este neclar, contactați furnizorul. not clear, contact the supplier.

6. ÎNAINTE DE UTILIZARE / INSTALARE



6.1 Testarea fluxului de aer

1		2	
Conectați tubul de respirație la unitatea turbo și răsuciți-l în sensul orar pentru a-l fixa pe poziție.		Introduceți debitmetrul la vârful tubului.	
3		4	
Apăsați butonul Pornire (ON) și mențineți tubul în poziție verticală la nivelul ochilor.		Fluxul de aer este suficient dacă indicatorul ajunge la nivelul minim 0.	

1. Aducția de aer trebuie testată înainte de utilizare.

2. Dacă indicatorul nu ajunge la nivelul minim 0, nu utilizați sistemul de protecție respiratorie. Schimbați filtrul sau acumulatorul și testați din nou fluxul de aer.

6.2 Testarea alarmei pentru aducția de aer

1		2	
Scoateți tubul de la masca și apăsați butonul Pornire (ON).		Acoperiți cu mâna orificiul de ieșire a aerului și așteptați aproximativ 15 secunde.	

Dacă alarma nu pornește, reparați sau schimbați sistemul de protecție respiratorie.

6.3 Instalare

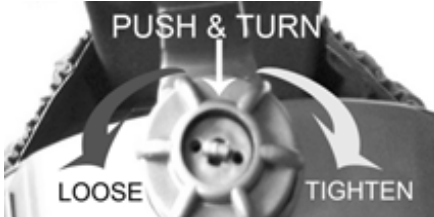
1		2	
Trageți elementul de etanșare pe față și puneți casca de protecție.		Reglați masca pe cap până o simțiți etanșă (împingeți și rotiți spre stânga pentru a slăbi, rotiți spre dreapta pentru a tensiona)	

Verificați dacă elementul de etanșare pe față este bine poziționat, altfel nu veți beneficia de etanșarea necesară pentru obținerea unui factor de protecție corect.

7. ECRANUL LCD ȘI MODUL DE UTILIZARE

7.1 Funcțiile LCD



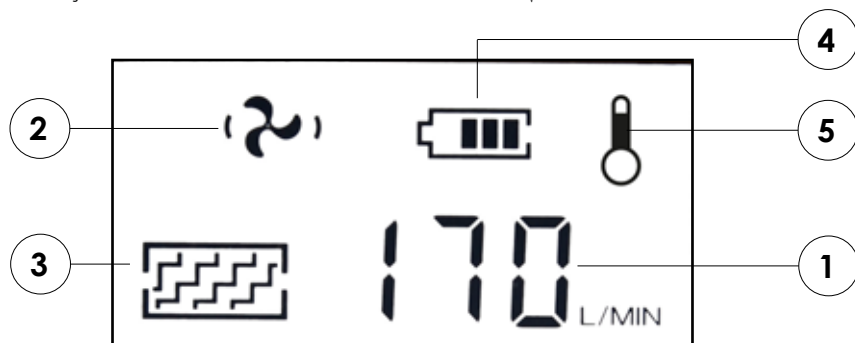





Ecranul LCD și unitatea PANTHER FLOW indică condițiile de lucru.



- 1 oferă date cu privire la debitul de aer actual.
- 2 indică nivelul debitului de aducție.
- 3 indică starea de funcționare a filtrului.
- 4 indică starea acumulatorului.
- 5 indică temperatura acumulatorului.

Oricare dintre indicatoarele de mai sus va clipi intermitent în cazul în care sistemul PANTHER FLOW funcționează anormal

7.2 Utilizarea sistemului

 1x ON	Puneți sistemul în funcțiune apăsând o singură dată pe butonul ON.	
 2x ON	Apăsați butonul ON încă o dată pentru ca fluxul de aer să atingă nivelul 1 (~170L/min).	
 3x ON	Apăsați butonul ON încă o dată pentru ca fluxul de aer să atingă nivelul 2 (~200L/min).	
 4x ON	Apăsați butonul ON încă o dată pentru ca fluxul de aer să atingă nivelul 3 (~230L/min). Apăsați butonul ON încă o dată pentru ca fluxul de aer să revină la nivelul 1 (~170L/min).	

1. Sistemul de protecție respiratorie va opri unitatea turbo cu presiune pozitivă dacă apăsați lung pe butonul Oprire (OFF) mai mult de 3 secunde.
2. Sistemul de protecție respiratorie va opri întregul circuit și va trece în modul de veghe dacă unitatea turbo este oprită mai mult de 30 de minute. Puteți activa sistemul apăsând pe butonul ON.
3. Sistemul de protecție respiratorie va fi utilizat în plajele de temperatură situate între - 5°C și +55°C, la o umiditate relativă sub 90%.

8. ÎNTREȚINEREA ȘI DEPOZITAREA SISTEMULUI

Controlați echipamentul zilnic și verificați-l întotdeauna dacă apare vreun semn de defecțiune.

8.1 Întreținere

- Sistemul de protecție respiratorie va fi verificat periodic și schimbat dacă este defect sau permite scurgeri.
- Filtrul trebuie să fie schimbat în cazul în care este spart sau blocat și nu permite trecerea unui flux de aer suficient.
- Tubul de respirație trebuie să fie schimbat în cazul în care este spart sau prezintă găuri.
- Acumulatorul trebuie pus la încărcat în momentul în care sună alarma de acumulator descărcat.
- Ștergeți suprafețele externe cu o cârpă moale. Nu folosiți apă!
- Filtrul ar trebui înlocuit cu prefiltrul.

8.2 Depozitare

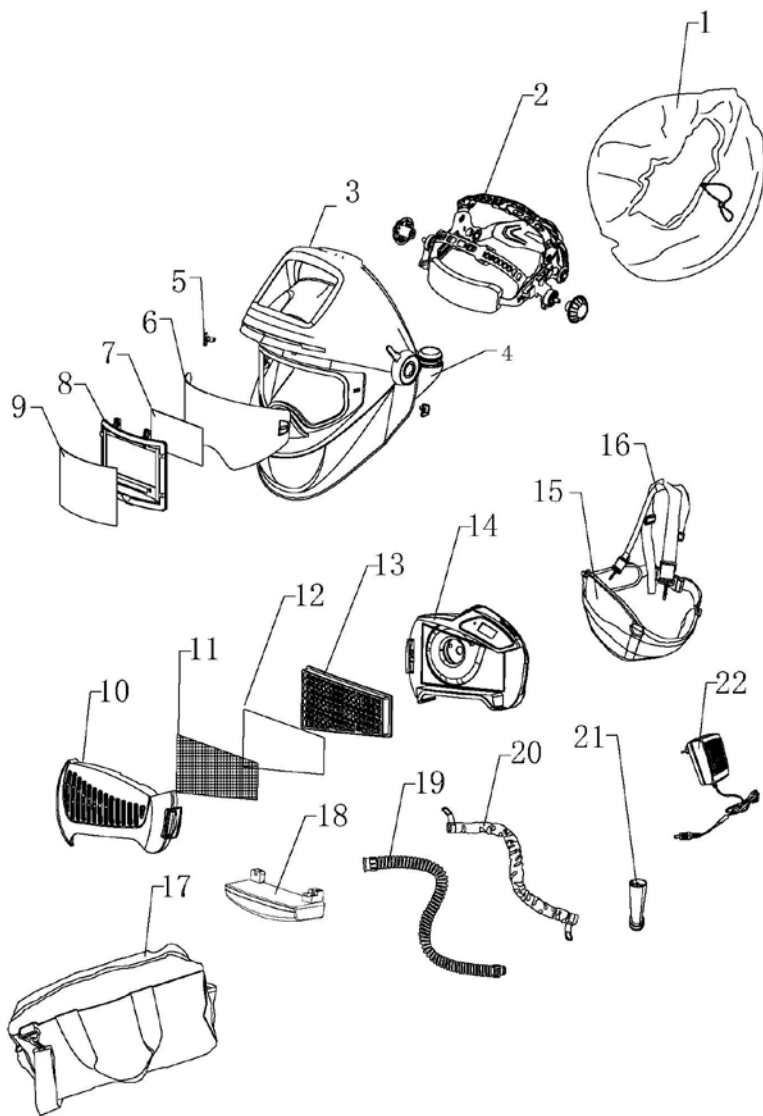

- Sistemul de protecție respiratorie va fi utilizat în spații curate, uscate, în plajele de temperatură situate între -10°C și +55°C, la o umiditate relativă sub 90%.
- Dacă echipamentul este utilizat la temperaturi mai mici de 0°C, acumulatorul va fi lăsat să se încălzească pentru a lucra la capacitate maximă. Echipamentul va fi protejat împotriva prafului, particulelor și altor contaminanți.
- Dacă nu utilizați echipamentul un timp îndelungat, încărcați complet acumulatorul, scoateți-l din sistemul de protecție respiratorie și depozitați-l separat.

10. LISTA PIESELOR DE SCHIMB



Desenul nr.	Cod articol	Descriere
1	8PNTHRFLW3FCSL	Hota protectoare pentru fata
2		Elemente de fixare a capului
3	8PNTHRFLXRC	PANTHER FLEX RC Felyitható Automata heg. fejpajzs
4	-	-
5	-	-
6	8PNTHRFLXGRL	Plexiglass de protecție panoramică de șlefuire
7	8PNTHRFLXINNCL	Lentila interioară
8	-	Automatikusan elsötétedő szűrő (ADF)
9	8PNTHR51OUTCL	Lentila exterioară
10	8PNTHRFLWFC	Capacul filtrului
11	8PNTHRFLWSPRKA	Parascântei
12	8PNTHRFLWPRF	Prefiltru x5
13	8PNTHRFLW3FLT	Filtru (TH3)
14	-	Unitate turbo
15-16	8PNTHRFLWWBDS	Curea, Harnașamentul pentru umeri
17	-	Geanta de transport
18	8PNTHRFLW3RCB	Acumulator încărcabil Li-ion (6800mA)
19-20	8PNTHRFLW3BRTA	Tub de respirație, caz
21	8PNTHRFLWPATU	Dispozitiv de testare flux aer
22	8PNTHRFLWBTTCH	Încărcător pentru acumulator

10. GHID DE DEPANARE

Mesaje de eroare	Cauza	Soluția
Cod de eroare «E01» + clipește indicatorul "Avertisment"	1. Motorul este gripat 2. Motorul este defect 3. Structura ventilatorului s-a defectat din cauza forței externe 4. Defecțiune circuit	Verificați și eliminați defecțiunea tehnică, apoi repuneți sistemul în funcțiune. Trimiteți sistemul înapoi la distribuitor dacă ecranul LCD afișează tot eroarea E01
Cod de eroare «E02» + clipește indicatorul "Avertisment"	1. Motorul este defect 2. Elicea se freacă de carcasa ventilatorului 3. Circuitul este alimentat cu curent excesiv.	Verificați și eliminați defecțiunea tehnică, apoi repuneți sistemul în funcțiune. Trimiteți sistemul înapoi la distribuitor dacă ecranul LCD afișează tot eroarea E02
 + clipește indicatorul "Avertisment" + alarma acustică	Acumulator descărcat	Încărcați acumulatorul
 + clipește indicatorul "Avertisment" + alarma acustică	Filtrul se închide Tubul se închide	Încărcați acumulatorul Îndepărtați obstrucția, schimbați filtrul Curățați tubul
 clipește intermitent + alarma acustică	Temperatură prea mare la acumulator	Oprii din funcționare și lăsați-l să se răcească
Nu este flux de aer, nu se declanșează alarma	1. NU se alimentează cu curent electric 2. Contactul de la acumulator este defect	Încărcați acumulatorul Verificați contactul
Timpul de funcționare al bateriei este prea mic	1. Acumulatorul nu este încărcat complet 2. Filtrul este blocat 3. Acumulatorul este defect	Încărcați acumulatorul Îndepărtați obstrucția, schimbați filtrul Schimbați acumulatorul
Aerul furnizat către cască miroase anormal.	1. Filtru spart 2. Tub spart 3. Caseta ADF la cască este spartă	Părăsiți imediat zona. 1. Schimbați filtrul 2. Schimbați tubul 3. Schimbați caseta ADF de la cască
Flux de aer insuficient către cagulă	1. Tub de respirație străpuns 2. Tub de respirație deteriorat 3. Filtrul este blocat	1. Verificați racordul tubului la cagulă și la sistemul de protecție respiratorie 2. Schimbați tubul de respirație 3. Îndepărtați obstrucția, schimbați filtrul

11. EXPLICAȚII PRIVIND MARCAJUL

Dispozitiv de filtrare motorizat:

- EN 12941:1998 Dispozitive de protecție respiratorie- Dispozitive de filtrare motorizate care încorporează o cască sau o cagulă de protecție - Cerințe, testare, marcare.
- Clasificare unitate: TH3 P R (SL). "TH3" este nivelul de protecție, "P R" indică tipul de filtru ("P"= Filtru de particule, "R"= filtre de particule de tip reutilizabil) și "SL" indică faptul că filtrul a fost testat în ceea ce privește particulele solide și lichide.

Indicatorul de avertizare acustic

Fiecare grilă reprezintă o perioadă de 100 ms. Zona gri indică avertizarea acustică, zona albă indică intervale fără avertizare acustică. Dacă mai multe grilele sunt marcate continuu cu gri, atunci avertizarea acustică este continuă.

De exemplu, dacă sistemul este supus unui curent de suprasarcină, sistemul emite un semnal de avertizare de tip

BIP BIP BIIIIIP

100 ms per grilă											
	0	1	2	3	4	5	6	7	8	9	10
Instalați acumulatorul											
Porniți sistemul											
Schimbați viteza fluxului de aer											
Opriți sistemul											
Curent în suprasarcină											
Blocare orificiu de ieșire aer											
Supraîncălzire											
Acumulator descărcat											
Blocare filtru											

USER'S MANUAL

PANTHER™ FLOW 3

Powered Air-Purifying Respirator System

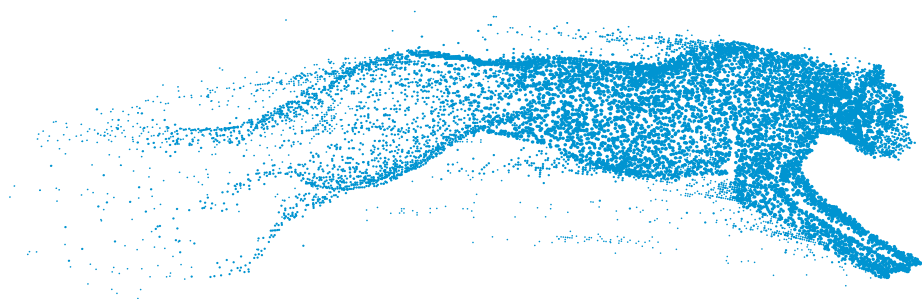

Warning!

Read and understand all instruction before using! Severe personal injury could occur if the user fails to follow the aforementioned warnings, and/or fails to follow the operating instructions.

1. INTRODUCTION

Respiratory System is a combined face and breathing protection device for increased safety and comfort during welding. Please read these instructions carefully before unpacking. For proper use, see User Instructions or contact manufacturers for help.

THE RESPIRATORY PROTECTION SYSTEM MUST NOT BE USED :

- In a dangerous environment for the user's health and safety, an environment with an oxygen level below 17% or containing unknown substances.
- In confined or non ventilated environments such as basement, etc.
- Near flames or thermal radiation.
- In explosion risk zone.
- In a very windy zone.
- If the respiratory protection system stops working: the user must leave the contaminated area immediately.
- If the filter is not installed.

DO NOT allow water or other liquids to enter the impeller chamber, the filter or battery compartment.

2. APPROVALS

The system complies with the requirements of European Standard:

EN12941:1998+A2:2008 class TH3 P R S L

The Respiratory System is designed to provide a supply of filtered air via a breathing tube to a welding headpiece. The equipment can be used in environment that requires a class TH3P breathing protection device. It protects against articulate contamination.

All components used in Respiratory System must be approved with manufacturer's parts, and must be used in accordance with the instructions in this manual.

Notified Body: INSPEC International Limited 56 Leslie Hough Way, Salford, Greater Manchester, M6 6AJ United Kingdom (Notified body number 0194)

- 1. The approval is not valid if the product is incorrectly used together with non-approved parts or components.**
- 2. Only the particle filter and pre-filter can be used together with this system. Filters from other manufacturers should under no circumstances be used.**

3. WARNING AND LIMITATIONS TO USE

Before each use, inspect the Respiratory System for damage and verify it operates properly. Before using the Respiratory System, test air flow to verify it is providing an adequate volume of air.

Always wear the Respiratory System and do not remove the head top or turn off the air filter unit until outside the contaminated area, otherwise, there is a risk of high concentration of CO₂ and oxygen level in the head top will fall, thus little or no protection is given.

If you are not sure about the concentration of pollution, or about equipment performance, ask the industrial safety engineer.

4. SPECIFICATION

Size (Blower Assembly)	240 x 165 x 70 mm
Welding shield	PANTHER FLEX RC
Air Filter	1 x TH3 P R SL
Air Flow	Manufacturer minimal flow rate: 165 l/min Nominal airflow : Level 1: 170 l/min Level 2: 200 l/min Level 3: 230 l/min
Noise Level	Max: 70 dB
Operate Temperature	-5°C~55°C
Storage temperature	-10°C~55°C
Battery Type	Rechargeable Li-ion 11.1V /6800mA
Expected Battery Operation Time	Level 1>8h Level 2>6h Level 3>4h
Battery Charging Time	3.5 Hours
Battery Life	500 Charges Run Time dependent on air flow rate and filter load.
LCD Display	Air flow level and data Battery capacity Battery temperature Filter status

5. UNPACKING/ASSEMBLY

Check that correct number of components has been supplied, as in figure 1.

Check that the apparatus is complete, undamaged and correctly assembled.

Any damaged or defective parts must be replaced before use.







The package must include:

1. The air fed welding + welding hood
2. The respiratory protection system (turbo unit + filter + waist belt)
3. Lithium-ion battery
4. The tube, its anti-fire cloth and both end fittings
5. The shoulder harness
6. The air flow tester
7. The lithium-ion battery charger
8. The carrying bag

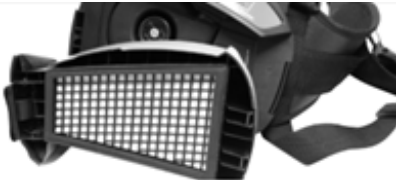



If any of the above components are not included in your kit, please contact the supplier immediately.

5.1 Filter replacement

1		2	 <p data-bbox="621 323 930 352">The filter cover is released.</p>
3		4	
5		6	 <p data-bbox="621 882 1009 938">Clean the spark arrester if necessary.</p>

The pre-filter and filter expected lifetime is 12 months. When under intensive use, check the filter cleanliness periodically and if needed, change them more often than every 12 months.

5.2 Installing and charging the battery

1		2	
Slide the battery towards the back of the filtration unit.		Make sure that the battery is locked in position.	
3		4	
The battery can be charged on the filtration unit or separately.			



The battery is partially charged when delivered. It must be charged at a 100% (4 bars) before the first use.

It is recommended to charge the batteries at a 100% before each use!



The charger must not be used for anything else than it was designed for.

Do not charge the battery in a potentially explosive area! The charger must only be used indoors!

The charger regulates the charge automatically, when the battery is fully charged, it will maintain it at 100% (floating charge).

The charging time is 3 to 4 hours.



The battery will discharge itself after long storage periods. Always charge the battery if the device was stored for more than 15 days. Once the battery is new or has been stored for more than 3 months, charge it and discharge it at least twice in a row to reach the nominal/rated charge capacity.

Battery charge :



1. Connect the battery to the charger. The connector is above the battery.
2. Connect the charger to the mains.
3. The state of charge is displayed via a red LED on the mains charger.
4. Once the charge is finished, the floating charge becomes active: the red LED switches off and a green LED switches on.
5. Disconnect the charger from the mains (do not keep the charger plugged to the mains if it's not in use).

5.3 Installing the respiratory system on the belt

1		2	
Remove the belt's release buckle.		Remove the fastening belt from the waist connector's 2 belt loops.	
3		4	
Make the fastening belt pass through the respiratory system's 2 belt loops.		Position the Velcro® between the 2 loops.	
5		6	
Flip the filtration system and attach the Velcro on the belt.		Put the fastening belt back through the 2 belt loops.	
7		8	
Put the buckle back.		Attach the harness to the belt's 4 plastic	

Make sure the belt is securely fastened!





5.4 Connecting the tube

1		2	
Connect the air tube to the respiratory system and twist it clockwise to lock its position.		Connect the other end of the tube to the headgear in the same way.	

**Check that the respiratory tube is strongly connected. If the tube is broken, replace it!
! All components must be installed/used in accordance with this manual if the equipment is to offer the specified protection. If any component is missing, or if anything is not clear, contact the supplier.**

6. BEFORE USE/FITTING

6.1 Air flow test



1		2	
Connect the breathing tube to the turbo unit and twist it clockwise to lock it.		Insert the flowmeter at the tip of the tube.	
3		4	
Press the ON button and maintain the tube in a vertical position at eyes' height.		The air flow is sufficient if the marble reaches the minimum flow level 0.	

1. The airflow must be tested before using.

2. If the marble can't reach the minimum flow level, don't use the system.

Change the filter or the battery and retest the air flow.

6.2 Air flow alarm test

1		2	
Remove the tube from the helmet and press the ON button.		Cover the air output with your hand and wait approximately 15 seconds.	

If the alarm does not work, please repair or change Respiratory System.

6.3 Fitting

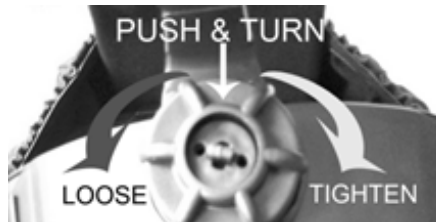
1		2	
Pull down the face seal ring and put on the head top.		Adjust the headgear to suitable tightness (push and turn left to loosen, turn right to tighten)	

Make sure the face seal is positioned properly, otherwise, you can't get sufficient sealing needed to offer the correct protection factor.

7. LCD AND OPERATION

7.1 LCD functions

The LCD on the PANTHER FLOW unit show the working conditions.



1 shows the data of current air flow.

2 shows the level of the airflow.









3 shows the filter condition.

4 shows the battery.

5 shows the temperature of the battery.

Any of them will flash if there are PANTHER FLOW malfunctions.

7.2 Operation

<p>1x ON</p> 	<p>Switch the device on by pressing the ON button once.</p>	
<p>2x ON</p> 	<p>Press the ON button once again, the air flow will be on level 1 (~170L/min).</p>	
<p>3x ON</p> 	<p>Press the ON button once again, the air flow will be on level 2 (~200L/min).</p>	
<p>4x ON</p> 	<p>Press the ON button once again, the air flow will be on level 3 (~230L/min). Press the ON button once again, the air flow reverts to level 1 (~170L/min).</p>	

1. Respiratory system will turn off the turbo unit if long press the OFF button more than 3 seconds.
2. Respiratory system will cut off the entire circuit and switch to sleep mode if the turbo unit has turned off for more than 30 minutes. Pressing the ON button can activate the system.
3. The Respiratory system must be operated in the temperature range of -5°C to +55°C and relative humidity less than 90%.

8. MAINTENANCE & STORAGE

Inspect the equipment daily and always check it if any sign of malfunction occurs.

8.1 Maintenance

- The Respiratory system unit must be checked regularly and must be changed if it is damaged and cause leakage.
- The filter must be changed if it is broken, or it is blocked and does not give enough airflow.
- The breathing tube must be changed if it is broken or has crevasse.
- The battery must be charged when the low battery alarm rings.
- Use a soft cloth to wipe the external surfaces. Don't use water!
- The filter should be replaced together with the pre-filter.

8.2 Storage

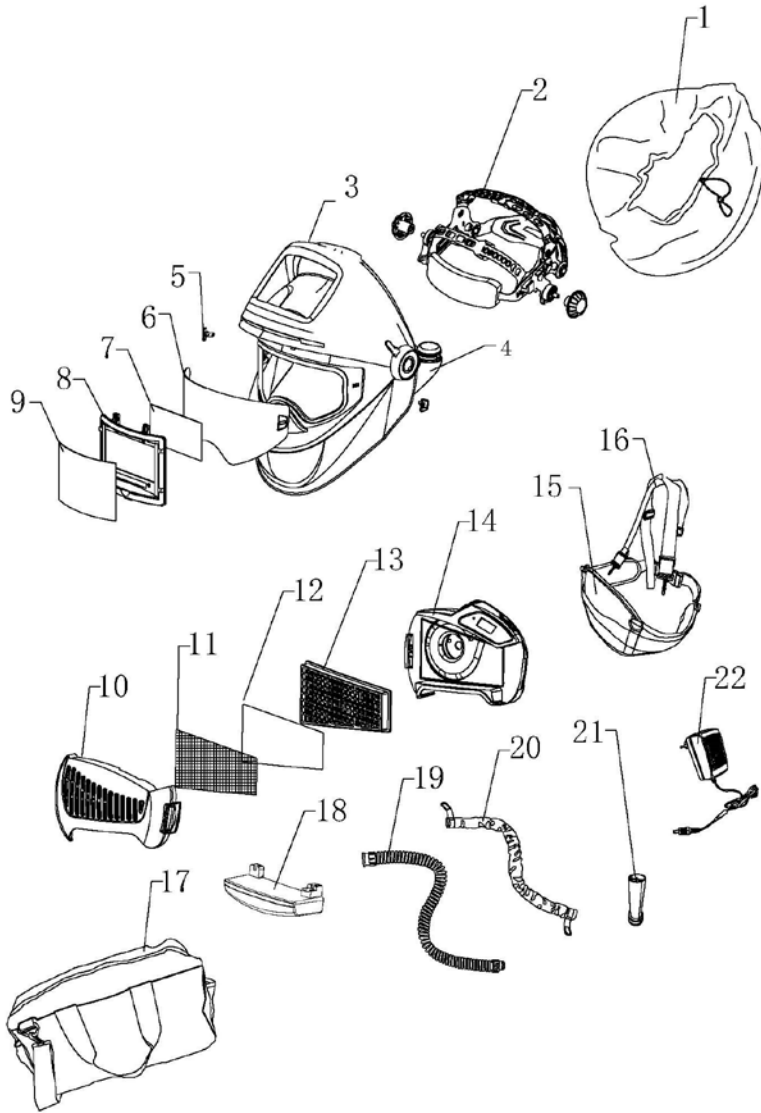

- The Respiratory system must be stored in a dry, clean area, in the temperature range of -10°C to +55°C and relative humidity less than 90%RH.
- If the equipment is stored at temperature below 0°C, the battery must be allowed to warm up to achieve full battery capacity. The equipment must be protected from dust, particles and other contamination.
- If the equipment is not used for a long time, the battery should be fully charged, removed from Respiratory system unit and stored separately.

9. PARTS LIST



Drawing No.	Part No.	Description
1	8PNTHRFLW3FCSL	Face seal
2		Headgear
3	8PNTHRFLXRC	PANTHER FLEX RC Flip-up, remote control Aut. LCD Weld- ing Helmet
4	-	-
5	-	-
6	8PNTHRFLXGRL	Grinding, panoramic cover lens
7	8PNTHRFLXINNCL	Inner Cover Lens
8	-	Auto-darkening Filter(ADF)
9	8PNTHR51OUTCL	Outer cover Lens
10	8PNTHRFLWFC	Filter Cover
11	8PNTHRFLWSPRKA	Spark Arrestor
12	8PNTHRFLWPRF	Pre-Filter x5
13	8PNTHRFLW3FLT	Filter (TH3)
14	-	Turbo Unit
15-16	8PNTHRFLWWBDS	Waist Belt, Shoulder Harness
17	-	Carrying Bag
18	8PNTHRFLW3RCB	Rechargeable Li-ion Battery (6800mA)
19-20	8PNTHRFLW3BRTA	Breathing tube with cloth ass.
21	8PNTHRFLWPATU	Air-flow Tester
22	8PNTHRFLWBTTCH	Battery Charger

10. TROUBLE SHOOTING

Error messages	Cause	Solution
Fault code «E01» + “Warning” blinks	<ol style="list-style-type: none"> 1. Motor is stuck 2. Motor is damaged 3. Blower structure failure caused by outer force 4. Circuit failure 	Check and remove physical failure and restart the system. Return to dealer if LCD still shows E01
Fault code «E02» + “Warning” blinks	<ol style="list-style-type: none"> 1. Motor is damaged 2. Motor impeller rubs blower shell 3. Circuit has excessive current. 	Check and remove physical failure and restart the system. Return to dealer if LCD still shows E02
 + “Warning” blinks + alarm sound	Low battery	Charge the battery
 + “Warning” blinks + alarm sound	Filter close up Tube close up	Remove obstruction, change the filter Clean tube
 blinks + alarm sound	Battery high temperature	Stop working and rest
No air flow, no alarm	<ol style="list-style-type: none"> 1. No power 2. Battery contact damaged 	Charge the battery Check battery contact
Battery run time is too short	<ol style="list-style-type: none"> 1. Battery is not fully charged 2. Filter is blocked 3. Battery is damaged 	Charge the battery Remove obstruction, change filter Change battery
Air supply to hood smells unusual.	<ol style="list-style-type: none"> 1. Filter broken 2. Tube broken 3. ADF helmet broken 	Leave current area immediately. <ol style="list-style-type: none"> 1. Change filter 2. Change tube 3. Change ADF helmet
Supply insufficient air to hood	<ol style="list-style-type: none"> 1. Breathing tube broken off 2. Breathing tube broken 3. Filter is blocked 	<ol style="list-style-type: none"> 1. Check tube connection to hood and Respiratory system unit 2. change breathing tube 3. Remove obstruction, change filter

11. MARKING EXPLANATION

Powered filtering device:

- EN 12941:1998 Respiratory protective devices- Powered filtering devices incorporating a helmet or hood- Requirements, testing, marking.
- TH3 P R (SL) classification of the unit.
 - “TH3” defines the level of protection,
 - “P R”: filter type (“P”= Particle filter, “R”= Reusable type of particle filters)
 - “SL”: the filter has been tested against particles of liquid and solid matter.

Warning sound indication

Each grid stands for a period of 100 ms. Gray is the beep sound and blank grid is a quiet period. If several continued grids are in gray then there's a continuous beep sound.

For example, when the current is overloaded, the system sounds like

BEP BEP BEEEEEP.

100 ms per grid											
	0	1	2	3	4	5	6	7	8	9	10
Install the battery	Gray										
Turn on the system	Gray										
Change the air flow speed	Gray										
Turn off system	Gray	Gray	Gray	Gray	Gray						
Current overload	Gray		Gray		Gray	Gray	Gray	Gray	Gray		
Air outlet jam	Gray		Gray	Gray	Gray	Gray					
Overheating	Gray		Gray		Gray		Gray	Gray	Gray	Gray	Gray
Low battery	Gray		Gray								
Filter jam	Gray		Gray		Gray						

